

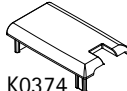

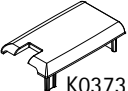









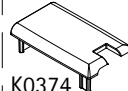
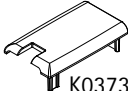
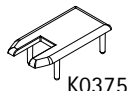

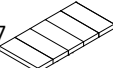
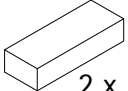
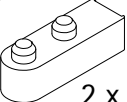

# 6128-6 Produktübersicht DT+ SW, Typ 0180 + 0181

01/17

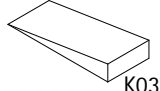
<b>ZF9455</b> 6 x 3,5 x 9,5 mm 	 K0374  K0373  K1517  K1518	<b>ZF9456</b> 6 x 3,5 x 9,5 mm 	 K0374  K0373  K0375
8 x 4,2 x 45 mm 	<b>Z168</b>  K0386  K0387  N0957  2 x  2 x	6 x 4,2 x 45 mm 	<b>Z167</b>  K0388  K0389 <b>Z0034</b>  K0352
8 x 		3 x 	3 x 

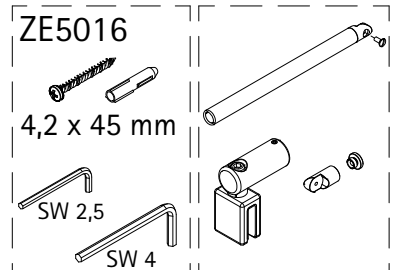
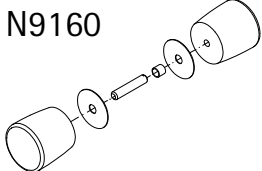
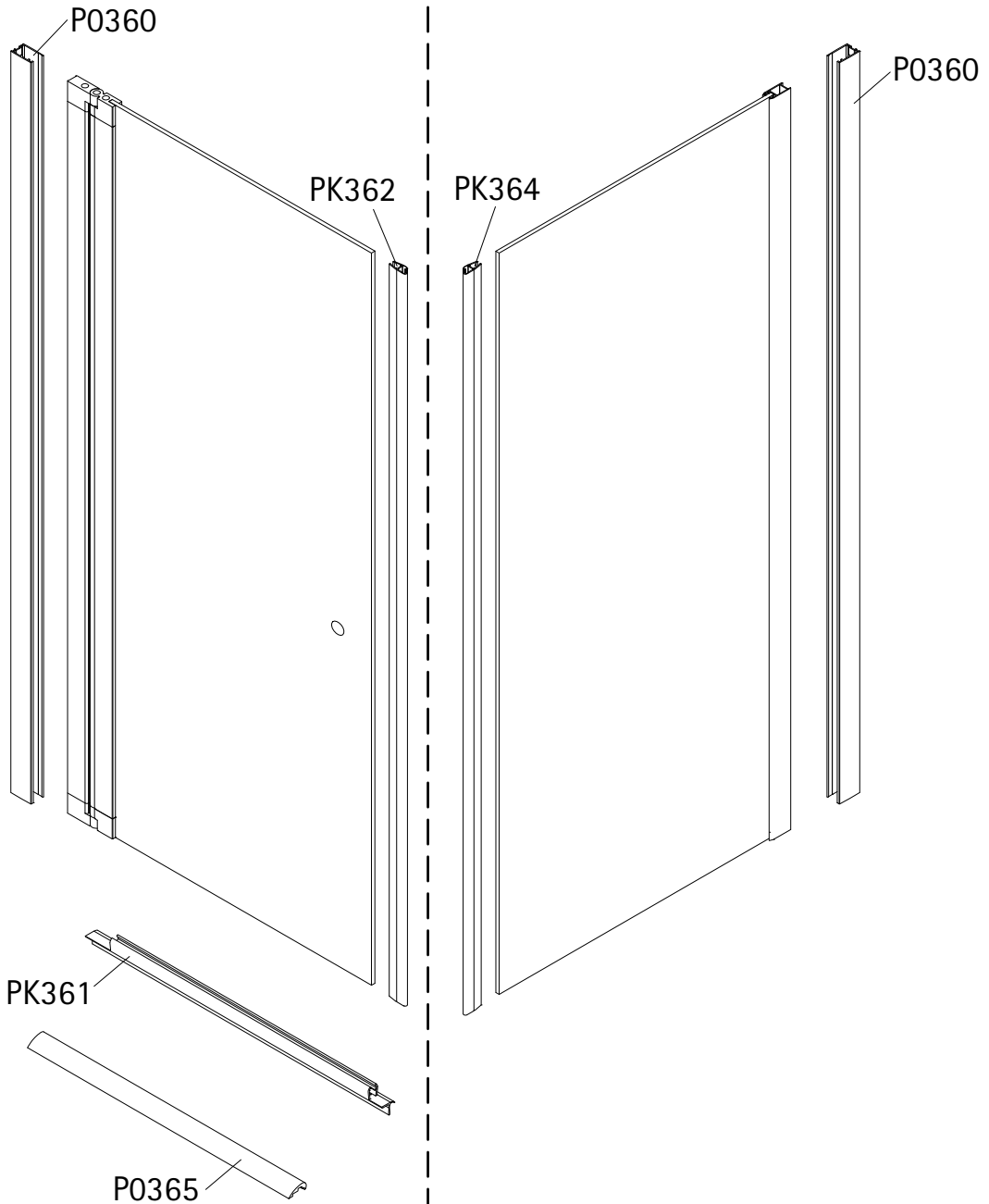

# Produktübersicht DT+ SW, Typ 3360 + 3361, 3366 Typ 9455 + 9456, 9457

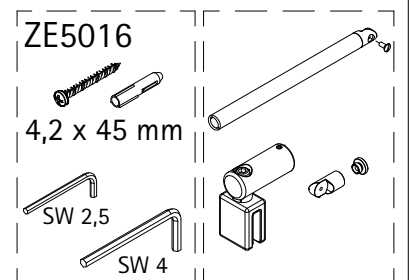
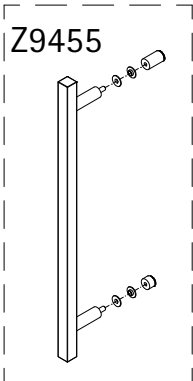
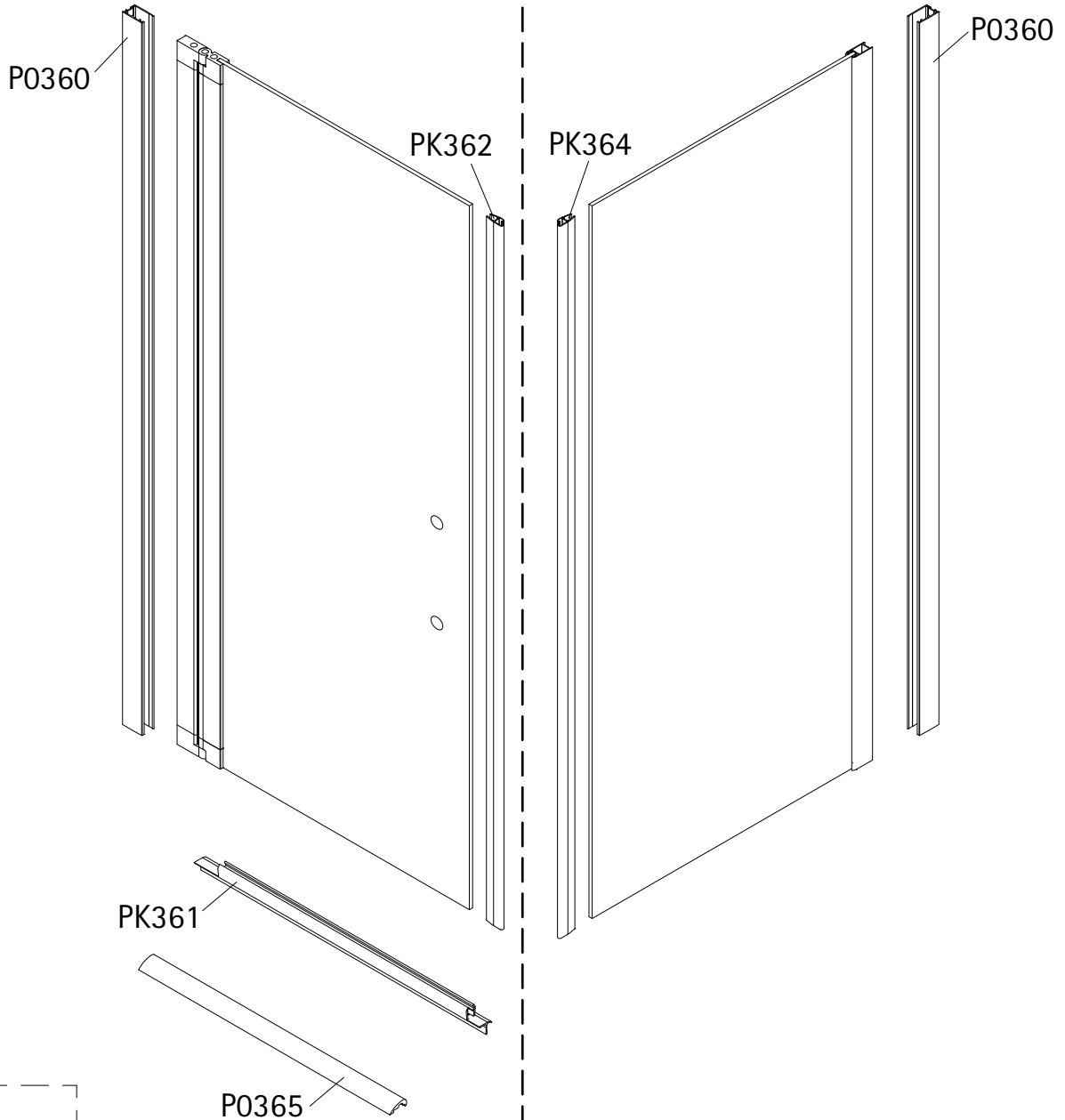
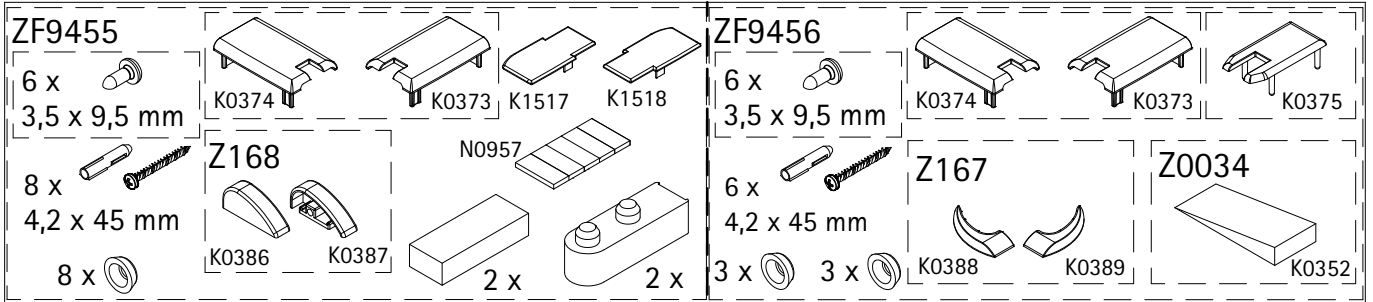

# Produktübersicht DT+ SW, Typ 1226 + 1230, 1231 Typ 5350 + 5351, 5352

